



**Series 800-H**  
**High-Frequency**  
**Pipe and Cable Locator**

**User Manual**



*Manufactured Exclusively By:*  
**Utility Tool Company, Inc.**  
**2900 Commerce Boulevard**  
**Birmingham, Alabama 35210**  
Tel    **205-956-3710**  
Fax    **205-956-3711**

view instructional videos at:  
[www.pipehorn.com](http://www.pipehorn.com)

## **DANGER! SHOCK HAZARD**

CONNECTING DIRECTLY TO ANY CONDUCTOR CAN BE HAZARDOUS AND RESULT IN ELECTRIC SHOCK, INJURY, OR DEATH. ONLY LICENSED OR AUTHORIZED PERSONS SHOULD MAKE DIRECT CONNECTIONS TO POTENTIALLY ENERGIZED CONDUCTORS.

This device complies with Part 15 of the FCC Rules. Operation is subject to the following two conditions: (1) this device may not cause harmful interference, and (2) this device must accept any interference received, including interference that may cause undesired operation.

### NOTICE

This User's Manual is provided as an informational guide only and is subject to change without notice.

This Manual contains certain information which is proprietary in nature and protected by U.S. and Foreign Patents, Copyrights, and Registered Trademarks. All rights are reserved. No part of this document may be photocopied, reproduced, transmitted, or converted into another language without the express written consent of Utility Tool Company, Inc.

Copyright © Utility Tool Company, Inc 2015

# CONTENTS

<b>General Information</b>	<b>4</b>
Equipment List	4
Advantages of the <b>800-H</b>	5
APWA Uniform Color Code	6
<b>Terminology</b>	<b>7</b>
<b>The Equipment</b>	<b>8</b>
The Transmitter	8
The Receiver	8
<b>The Signal</b>	<b>10</b>
<b>Pinpointing</b>	<b>11</b>
<b>Inductive Locating</b>	<b>12</b>
Apply the HF Signal	12
Determine the Source of Signal	13
Verify the Conductor Pinpointed	14
<b>Search and Sweep</b>	<b>15</b>
One Person	15
Two Person	16
<b>Conductive Locating</b>	<b>18</b>
Applying Signal to the Conductor	18
<b>System Check</b>	<b>20</b>
<b>Maintenance</b>	<b>21</b>
<b>Warranty</b>	<b>22</b>
<b>Repair Service</b>	<b>23</b>

## GENERAL INFORMATION

The Pipehorn Series 800-H is a state-of-the-art, single-frequency, pipe and cable locating system designed for the professional with complex locating jobs. It is a carefully engineered, precision instrument that, with reasonable care, will give many years of satisfactory service. The 800-H is very simple to operate, but for best results, the operator should carefully read this manual.

The 800-H can operate as a high-frequency inductive or conductive locator.

This equipment is used to locate and trace all types of buried or concealed conductors such as: pipe, cable, tracer wire, traceable fiber optics, or even sewer snakes or fish tape inserted into non-conductive pipe. The 800-H has an audible response as well as a visual response to help verify the locate and to help give an estimated depth.

### Equipment List

The 800-H consists of the following:

- ① Receiver
- ② High-Frequency Transmitter
- ③ Set of Conductive Cables
- ④ Ground Rod
- ⑤ Quick Guide
- ⑥ Instruction Manual
- ⑦ Vinyl Carrying Case

## Advantages of the 800-H

Every locating job is different. Success calls for a unique blend of equipment, experience, and persistence. In some situations, a low-frequency, conductive locator will perform better than a high-frequency, inductive locator. In other situations, the reverse is true.

The advantage of the high-frequency is that it traces poor conductors, can locate short lengths better than the low-frequency, and it does not have to be directly connected, though this method is available. Inductive operation is much faster and easier allowing the operator to move the signal to any place which is useful. The disadvantage of high-frequency during inductive locating is that it can place more signal on adjacent conductors, making isolation more difficult.

The 800-H is capable of both inductive and conductive modes. During conductive mode the high-frequency no longer induces signal which helps isolate the target.

The Receiver has a meter to show signal strength which is helpful in noisy situations. This meter also aids in depth estimation. We have also tuned the Receiver's audio feedback to produce tones that are most audible by the human ear.

## **SAFETY FIRST!**

**DANGER! Shock Hazard. Connecting directly to any conductor can be hazardous and result in electric shock, injury, or death. Only licensed or authorized persons should make direct connections to potentially energized conductors.**

Always exercise good safety procedures when operation locating equipment. These include, hooking a transmitter directly to energized conductors only when licensed or authorized, being constantly aware of traffic and equipment operating nearby, and removing any flammable or toxic liquids and gases from the area before using a locator.

**Employing proper safety practices during locating tasks will perhaps avoid an accident and may save your life.**

## **APWA Uniform Color Code**

Use this code for marking buried utilities. This code is used to identify the various types of underground utilities. Make sure the color you use corresponds to the chart below for the type of utility you are marking.

**Electric Power Lines or Conduits - Safety Red**

**Communication Lines or Cables - Safety Alert Orange**

**Storm & Sanitary Sewers - Safety Green**

**Water - Safety Precaution Blue**

**Proposed Excavation Area - High Visibility White**

## TERMINOLOGY

When the following terms are used in this manual, they have the meanings specified below:

**Conductor** - pipe, cable, conduit, traceable optic fiber, tracer wire/tape, sewer snake, fish tape, or other lines needed to find.

**Tracer Signal or Signal** - the output from a transmitter, either directly or through the air, which is carried along the conductor and detected with the Receiver.

**Inductive** - place the tracer signal on the conductor without making a direct electrical contact.

**Conductive** - place the tracer signal on the conductor by making a direct electrical contact or "direct-hookup"

**HF** - high-frequency

**Sensitivity** - the amount of signal the Receiver is set to detect; increasing the sensitivity allow the Receiver to detect weaker signals when it is farther from the Transmitter or conductor, as the case may be. Also known as "GAIN"

**Saturated Tone** - when the Receiver sensitivity is set too high and the tone no longer changes as you pass over a conductor. In other words the Receiver is receiving too much signal from the Transmitter and can no longer pinpoint the line. The 800-H Receiver will beep during saturation. Lower the sensitivity to eliminate saturation and allow for better pinpointing.

**Search & Sweep** - refers to scanning the area using the high frequency to find all of the conductors in the ground. Can be performed by one or two people.

## THE EQUIPMENT

### Transmitter

Modes: Inductive - HF  
Conductive - HF  
Signal Clamp - HF



During **Inductive Mode** the High-Frequency is being induced. To put the most signal on a conductor, place the handle of the Transmitter in-line and directly over the conductor.

During the **Conductive** or **Signal Clamp Mode** the high-frequency is no longer inducing and all signal is focused on the target conductor. For maximum benefit, place the ground rod as far away as possible at 90° from the conductor. Remember to ground away from trouble including adjacent conductors, fences, & other metallic structures

The 800-H Transmitter produces an audible tone when the unit is ON. When the tone is a high pitch, then a good signal is being put out. If during Conductive mode, a low pitch is heard then there is poor signal being placed on the conductor. This could be due to a bad ground or poor connection to the pipe, etc. If the Transmitter starts beeping then the batteries are getting low.

### Receiver

The Receiver can be used during all modes described above. Signal response feedback is given by an audio speaker and a meter.





## Receiver Continued...

To turn the 800-H Receiver ON, simply turn the sensitivity knob until it clicks.

The higher the number on the knob, the more sensitive the Receiver is.

Higher No. = More sensitivity

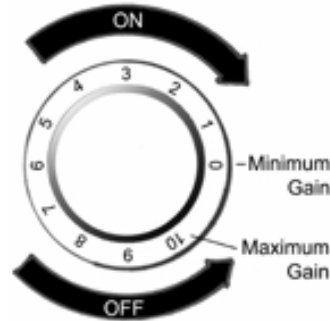

Both the audio speaker and the meter let you know when the Receiver is over a conductor.

When the needle on the meter reaches 10 it is at peak signal. Beyond 10 the signal becomes saturated and you need to lower the sensitivity.

To save battery life, the Receiver turns itself OFF after 5 minutes of no use. To reset the Receiver and turn it back ON, simply turn the switch OFF and back ON.

The sound the receiver makes is as follows:

High Pitch = close to conductor  
Low Pitch = moving away from conductor  
Beeping = sensitivity is too high

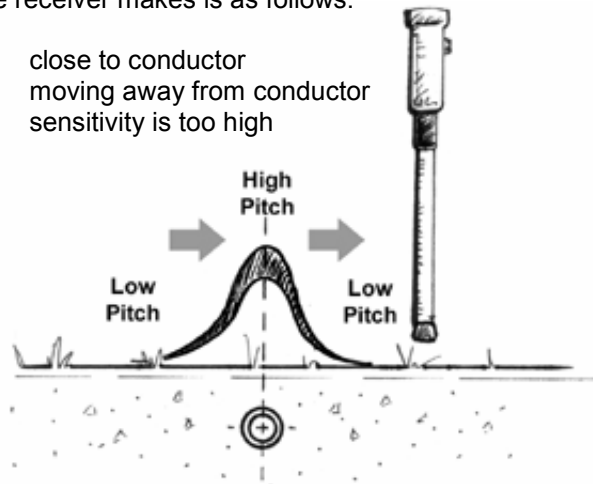

## THE SIGNAL

At any given distance, say 2 feet, at any direction from the conductor, the strength of the signal is the same under most conditions. This allows the Receiver to pinpoint directly over the conductor, as shown below, because that is the area with the peak (strongest) signal reading.

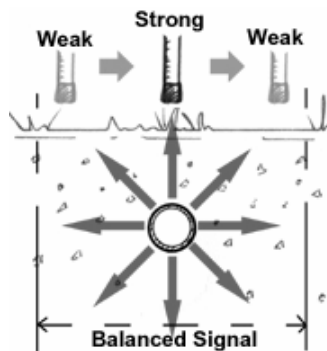

While locating always hold the Receiver vertically, and in the direction of the pipe (in-line with the handle). Swinging the Receiver as you scan may lead you to interpret the signal incorrectly.

Under ideal situations you will receive a balanced signal, as shown above. However, in some cases an un-balanced signal will occur, usually due to interference from another conductor, as shown below.

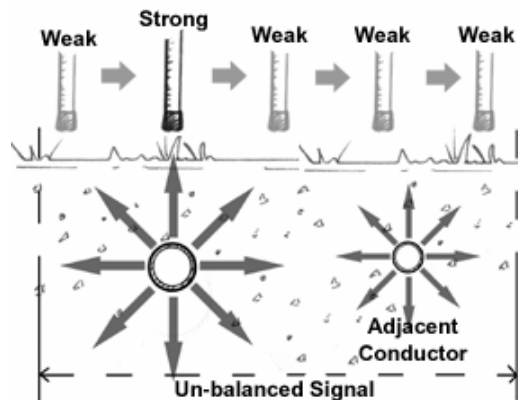

## PINPOINTING

As you move closer to the conductor the Receiver's sound becomes a higher (shrill) pitch. As you move away from the conductor the pitch lowers and will eventually go away. **Always maintain a solid, non-beeping tone from the Receiver to ensure proper alignment with the conductor.**

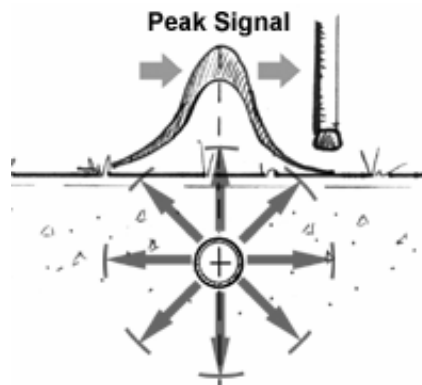

Be careful when on a hill or steep bank. Try to keep the Receiver level, not parallel to the hill. The Receiver will go towards the strongest tone, and if it is kept parallel to the hill side that tone will **NOT** be directly over the conductor as shown below. The deeper the conductor is, the worse this problem becomes.

### INCORRECT

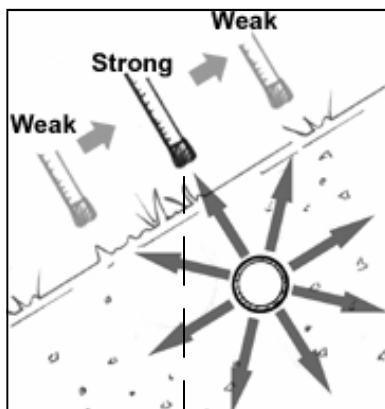

### CORRECT

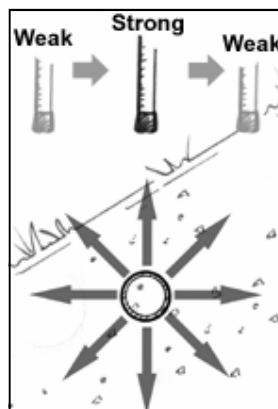

## INDUCTIVE LOCATING

This method is used when there is no direct access to the target conductor. It is also helpful in finding conductors with locations that are unknown.

With the 800-H the High-frequency is induced onto the conductor. It will only do so when the connection cables have been disconnected from the Transmitter.

### Starting From a Known Point

Use the following steps to begin tracing a conductor from a known point such as, a meter, valve, pedestal, or line marker, where access to the conductor for direct hook-up is not possible or is prohibited.

### Apply the HF Signal

Place the 800-H Transmitter directly over the conductor with the handle in-line with the conductor, as shown below. Careful alignment and placement of the Transmitter will maximize the signal on the conductor. Turn the Transmitter ON.

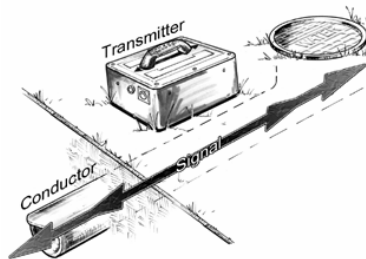

### Set Up the Receiver

Depending on the depth of the conductor, move 20-30 feet away from the Transmitter. The deeper the conductor, the farther away from the Transmitter you must start. Face the Transmitter and position the Receiver antenna near the ground. Set the Receiver to receive High-Frequency as explained on page 8. Move the sensitivity knob clockwise to turn the receiver ON.

## Set Proper Sensitivity & Scan the Area

Adjust the sensitivity knob to get a solid, non-beeping tone from the Receiver. Scan to the left or right to find the stronger signal. The higher pitch sound indicates you are getting closer to the conductor, a lower pitch sound indicates you are moving away from a conductor. If the sound starts beeping, lower the sensitivity and continue scanning.

## Pinpoint the Conductor

When scanning and the sound peaks, or changes from LOW to HIGH to LOW pitch, then you have come across the conductor. Be sure the tone dies off evenly on both sides of the peak (letting you know you have a balanced signal). The peak, or highest pitch, indicates when the antenna is directly over the conductor as described on page 11.

## Determine Source of Signal

After pinpointing, raise the receiver antenna and point it at the Transmitter. If the signal does not get significantly weaker, then the signal is coming through the air from the Transmitter more so than from the conductor. There may be no conductor or you may be too close to the Transmitter. Move farther away from the Transmitter, pinpoint again, and re-check as shown below.

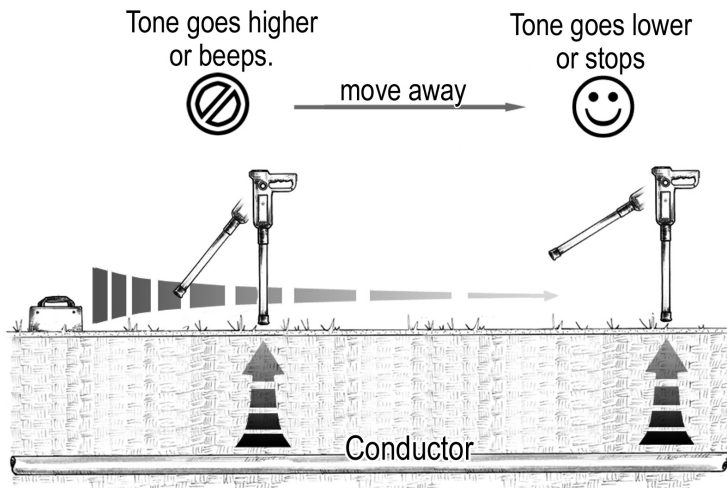

## Verify the Conductor Pinpointed

Mark the spot where you have pinpointed the line and check the direction by twisting the Receiver left and right to get the strongest signal.

Now place the Transmitter on the mark, in-line with the conductor, and trace the conductor back to its source.

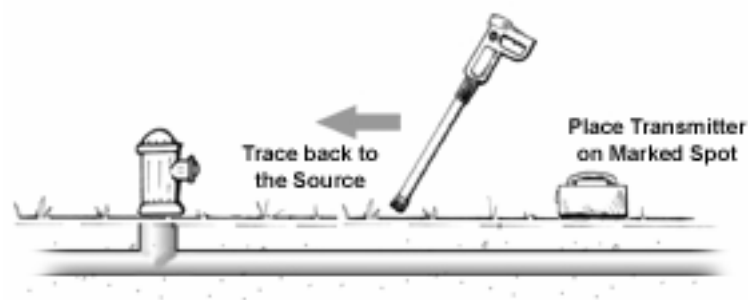

## Trace the Conductor's Path

When satisfied that you've found the target conductor, begin walking away from the Transmitter, tracing the path of the conductor by sweeping the antenna left and right. Always keep the antenna level and listen for the LOW-HIGH-LOW sound change. Trace as far as necessary adjusting the sensitivity control to maintain a solid, non-beeping tone.

## Weak or Confusing Signal

When the sensitivity control is fully clock-wise or the tone becomes jittery or unclear, reposition the Transmitter at the last clear location and continue tracing.

## SEARCH AND SWEEP

### One Person

This technique is beneficial in finding conductors with unknown locations, and with no access points. Basically you use the equipment in a way that scans the entire ground to find all conductors in a specific area. Please read the instructions for inductive locating before proceeding.

### Position the Transmitter

Lay the 800-H Transmitter on its side, as shown below. This will “flood” the area with signal. Turn ON the Transmitter.

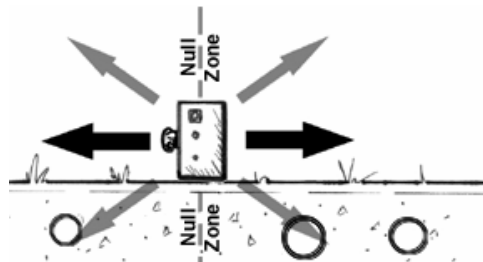

### Set Up the Receiver

Set up with the Receiver the same as you would during inductive locating. Move 5-10 feet from the Transmitter, face the Transmitter with the antenna near the ground, and turn the Receiver ON. **Set the sensitivity control so that the meter reads 4 and you hear a LOW pitched tone.**

### Locate the Conductor(s)

With the receiver facing the Transmitter, walk in a circle around the Transmitter. Keep a steady distance from the Transmitter and from the ground. Listen for the HIGH pitch tone areas, DO NOT adjust the sensitivity. After locating the HIGH pitch areas, go back and pin-point the conductors in those areas. You may need to re-adjust the sensitivity at this step, looking for the LOW-HIGH-LOW sound change. Mark the places with the highest tones for further pinpointing later.

## For Full Coverage

Re-locate the 800-H Transmitter at least once several steps to the right or left in order to provide complete coverage. This is because any conductor which is directly underneath the Transmitter will not be detected.

## Pinpoint and Determine Signal Source

As with normal Inductive Locating, place the 800-H Transmitter upright on one of the marks made earlier, (in line with the suspected run of the conductor). Pinpoint the conductor on the other side of the search area in the normal manner, as described on page 11.

After pinpointing the conductor, raise the receiver toward the Transmitter to be sure the signal is mostly coming from the conductor and not through the air, as described on page 13.

Repeat this process for each of the HIGH pitch areas found earlier and mark the lines accordingly.

# SEARCH AND SWEEP

## Two Person

Generally, two people can perform a search over a broad area quicker than one person.

## Set Up the Search

Start over an area where there are no conductors. One person holds the Transmitter to his/her side in line with the suspected run of the conductor(s). The other person stands approximately 30 feet away from the Transmitter, holding the Receiver to his/her side. (Be sure the receiver is set to receive High-frequency, page 8.) Turn both units ON, and keep them pointed at each other. Set the Receiver's sensitivity control so that the meter reads 4 and you hear a LOW pitched tone. The tone will get higher as you get closer to conductors.



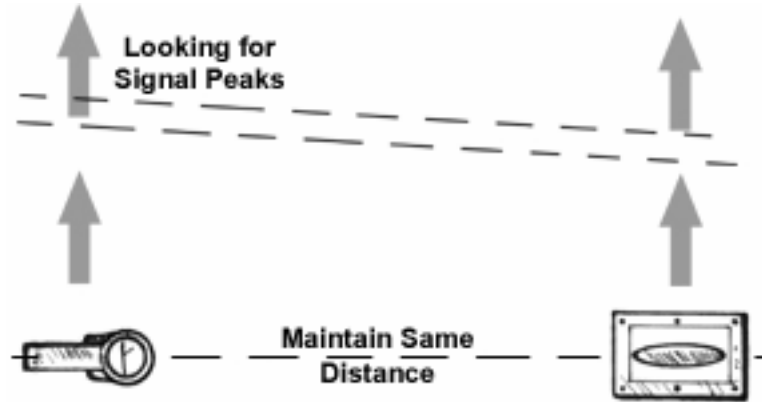

### Sweep the Area for Conductors

Maintain a constant distance between the Receiver and the Transmitter. Move together across the area where the conductors are suspected to run. DO NOT adjust the sensitivity during the sweep. When the operators sweep together over a conductor, the tone from the Receiver will get HIGH (shrill) or begin beeping, indicating a stronger signal. Temporarily mark the high pitch areas for pinpointing later.

### Pinpoint and Determine Signal Source

Set the Transmitter down in one of the high pitch areas found, and pinpoint with the Receiver (page 11). After checking direction, get a good solid tone on the receiver and let the other person pinpoint using the Transmitter. Move the Transmitter left and right until the receiver gets the strongest (highest pitch) signal response. At this point the Transmitter and receiver are directly over the conductor.

After pinpointing the conductor, raise the receiver toward the Transmitter to be sure the signal is mostly coming from the conductor and not through the air, as described on page 13.

### Conductors Going in Different Directions

Set up as before in different directions to sweep the area for conductors running at 45° and 90° to the original locating position.

## Conductive Locating

Conductive locating is done when there is an access point available for direct connection to the target conductor. This technique applies maximum signal to the target conductor with minimal signal applied to adjacent conductors.

The 800-H puts out the High-frequency during Conductive Locating. Conductors, such as deep high-pressure gas mains, communication cables, and other insulated continuous pipes and cables, tracer wire and tape which may have breaks, as well as poor conductors like cast iron with partially insulating couplings are all candidates for HF locating.

Only licensed or authorized persons should make direct connections. DO NOT HOOK DIRECT TO LIVE POWER CABLES. Make certain that the owner of the conductor has authorized direct hook-up for purposes of locating.

### Applying Signal to the Conductor

Remove any rust, paint, or other insulating substances from the point of contact with the conductor.

Position the supplied Ground Rod as far away from and 90° from the conductor as possible. Try to avoid grounding over an adjacent conductor. Connect to the Conductor, then to Ground, then insert the phono plug into the jack, and last, turn the Transmitter ON.

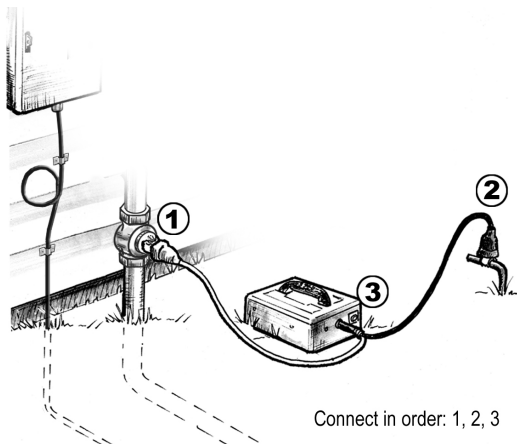

Connect in order: 1, 2, 3

## Trace the Conductor

From the Receiver select which frequency you wish to trace with. Sometimes one frequency will trace better than the other. Step a few feet from the Transmitter in the direction of the suspected conductor and set the sensitivity to get a solid steady tone from the Receiver.

Begin walking away from the Transmitter along the path of the conductor while sweeping the receiver's antenna left and right maintaining the LOW-HIGH-LOW tone pattern.

## Verify the Conductor

After marking the conductor along the path away from the Transmitter (30 ft. recommended), move the transmitter to that spot and inductively trace back to the source point (as described on page 14. This will help ensure that you are on the right conductor.

For other locating tips, call us at **205-956-3710** or check out our website at **[www.pipehorn.com](http://www.pipehorn.com)**.

## System Check

Verifying the Transmitter, Receiver, Conductive Cables, and optional Signal Clamp are operational before use is recommended.

### Check Induction

Place the transmitter on the ground away from utility lines and other interfering metal objects, such as vehicles and fences. Turn it on and listen for the high-pitched tone indicating good battery and good signal. Set the Receiver's sensitivity knob precisely at 2. The Receiver should be beeping when against the Transmitter as shown. Move in a line away from the Transmitter. The beeping tone should continue for at least 3 feet.

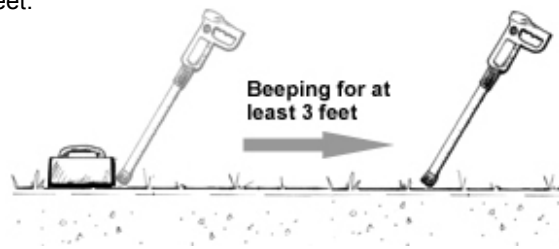

### Check Conduction & Clamp

Plug the conductive cables into the Transmitter. The Transmitter makes a low tone because the clips are not connected to anything. Connect the clips together. A high-pitched tone from the Transmitter indicates good signal and good cables. Place the cables in a loop. With the knob still at 2, touch the Receiver to the red wire keeping the handle in-line with the wire as shown. A beeping tone from the Receiver indicates conduction is operational. To check the optional Signal Clamp, plug it into the Transmitter and listen for the good signal tone. Place the Receiver tip inside the Clamp's ring. A beeping tone from the Receiver indicates the Clamp is operational.



If the locator fails the checks above, or if the Transmitter makes a beeping tone, or if the Receiver's volume is low, replace batteries and repeat checks. If it fails again with good batteries, the locator may need repair.

## MAINTENANCE

The Pipehorn Series 800-H does not require periodic calibration or any further internal adjustments. With reasonable care it should give many years of trouble free service.

### Batteries

The Receiver and Transmitter contains alkaline batteries for their power source and you should change them periodically. How often the instrument is used determines battery life. If the Receiver's volume is low, the Transmitter is producing a beeping tone, the operation distance decreases, or if the instrument becomes inoperative, it is likely the result of dead batteries. You should install fresh batteries as necessary. Change the batteries at least once every six months to be certain that the instrument will be ready to operate when needed.

NOTE: The usual reason for an inoperative unit is that the power switch was not returned to the OFF position when work was completed. The Receiver times out after 5 minutes of no use, and the Transmitter creates an audible tone letting the operator know it is still turned on.

Receiver:  
2 Eveready #522 alkaline 9V  
or equivalent

Transmitter:  
8 Eveready #E93 alkaline  
"C" cells or equivalent

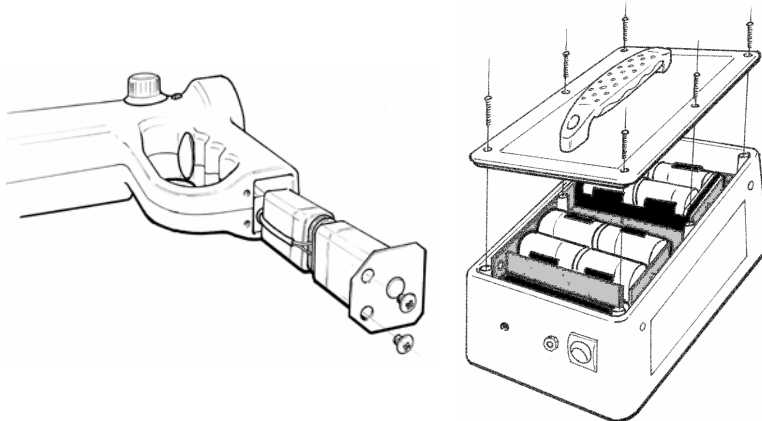

## WARRANTY

THERE ARE NO WARRANTIES, EXPRESS OR IMPLIED, INCLUDING ANY WARRANTY OF MERCHANTABILITY, BEYOND THOSE STATED BELOW.

Utility Tool Company, Inc. warrants the equipment it manufactures to be free from defects in workmanship or material, under normal and proper use and service by the original user, for three years from the date of original shipment from the factory. Batteries and other expendable items are not included in this Warranty. Unauthorized repair, alteration, or improper maintenance will void this Warranty. Alteration or removal of the serial number will also void the Warranty. Utility Tool Company will not be obligated under this Warranty if the equipment has been misused, misapplied, or accidentally damaged.

If a product is found defective under this Warranty, Utility Tool Company will, at its option, repair or replace the unit free of charge at Utility Tool Company's factory. The unit should be returned to the factory prepaid with customary shipping precautions. Utility Tool Company's obligations under this Warranty are limited to the repair or replacement of defective parts which are not the result of alteration, misuse, abuse, or accidental damage, or at the option of Utility Tool Company, the refund of the purchase price. Utility Tool Company assumes no other liabilities, contingent or consequential, to any equipment found defective under this Warranty.

## REPAIR SERVICE

For fast service (usually less than 48 hours), return the unit pre-paid to:

**Utility Tool Company, Inc.  
2900 Commerce Blvd.  
Birmingham, Alabama 35210  
Phone (205) 956-3710**

If you have questions or suggestions regarding our equipment or a particular application, contact our applications support group at the number listed above between 8:00am and 4:30pm Central Time.

Thank you for purchasing the Pipehorn equipment. We value your business and want to keep it. Please fill in the following for your records:

Pipehorn Series 800-H Serial Number:

\_\_\_\_\_

Date of Purchase: \_\_\_\_\_

Also, check out our website for more tips and information at:

**[www.pipehorn.com](http://www.pipehorn.com)**

**view instructional videos at:  
[www.pipehorn.com](http://www.pipehorn.com)**

